



# Pan-American Open Bariloche 2020

(ARG Bariloche, 7-8 March 2020)

# -48 kg

7 Judoka

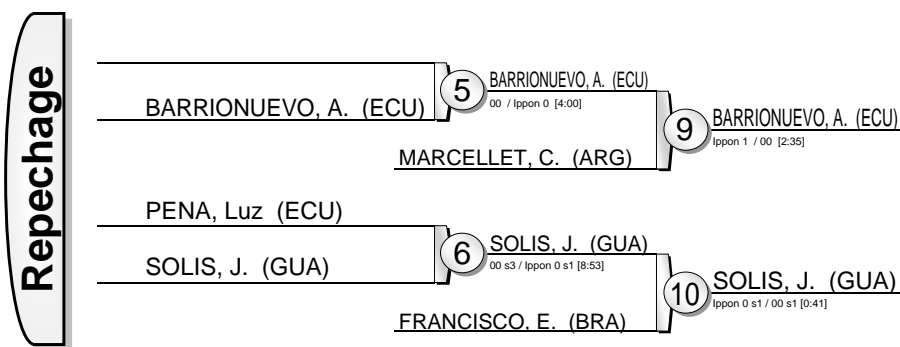
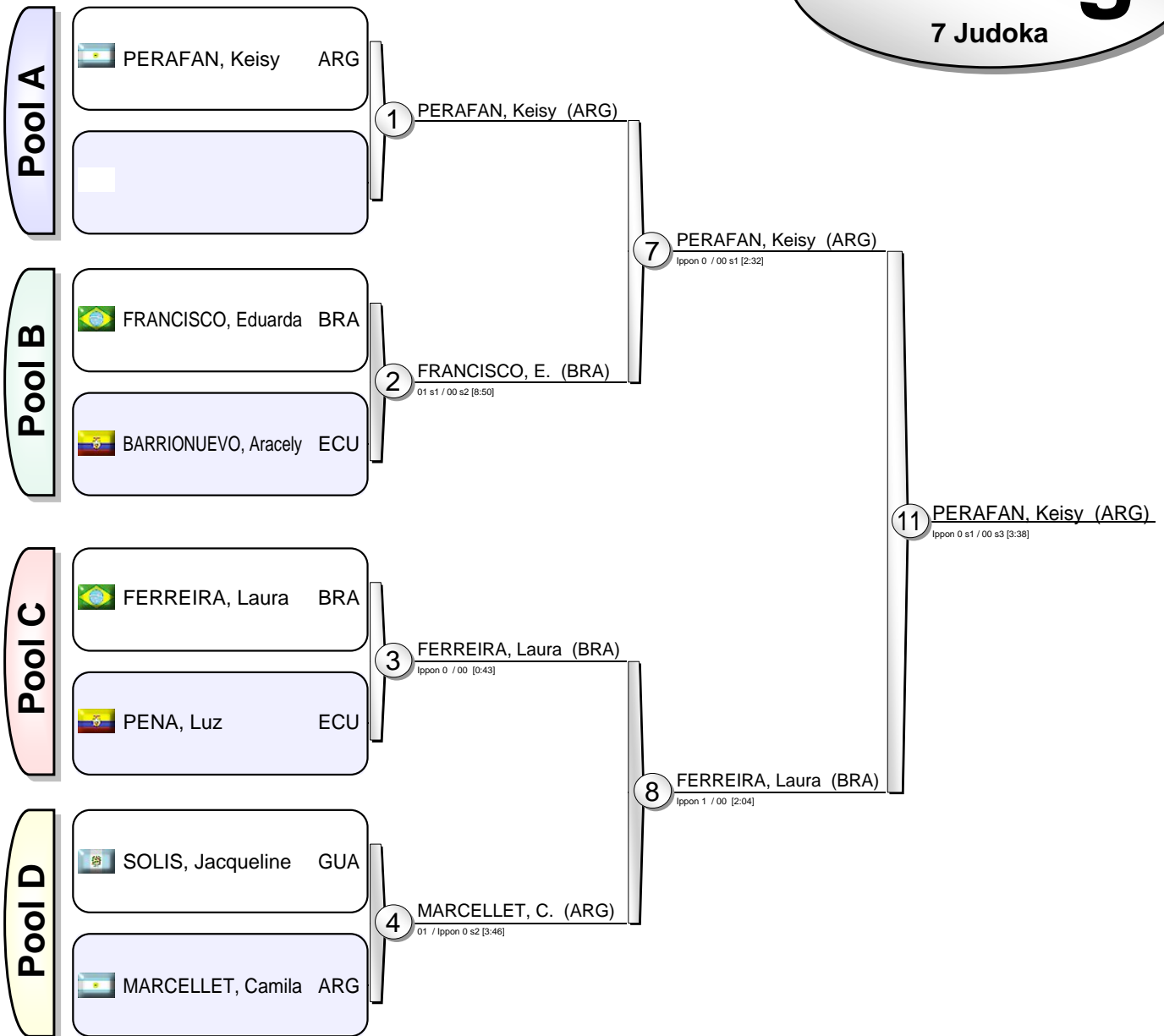

Results		
1.	PERAFAN, Keisy	ARG
2.	FERREIRA, Laura	BRA
3.	BARRIONUEVO, Aracely	ECU
3.	SOLIS, Jacqueline	GUA
5.	MARCELLET, Camila	ARG
5.	FRANCISCO, Eduarda	BRA
7.		
7.	PENA, Luz	ECU



# Pan-American Open Bariloche 2020

(ARG Bariloche, 7-8 March 2020)

# -52 kg

8 Judoka

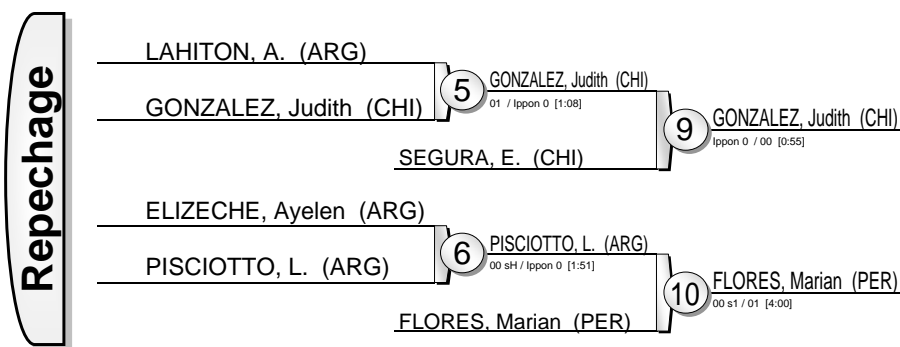
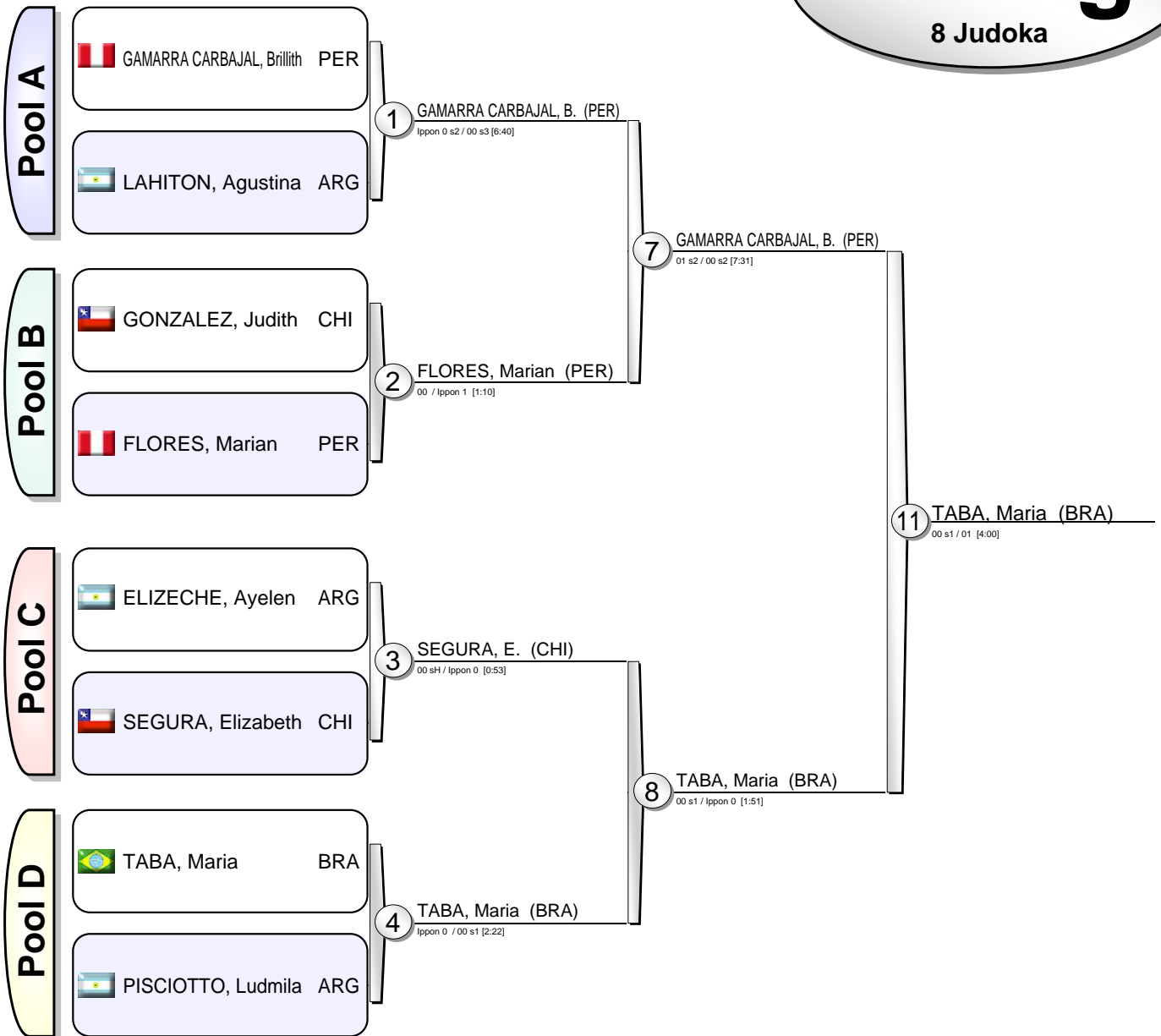

Results		
1.	TABA, Maria	BRA
2.	GAMARRA CARBAJAL, Brillith	PER
3.	GONZALEZ, Judith	CHI
3.	FLORES, Marian	PER
5.	SEGURA, Elizabeth	CHI
5.	PISCIOTTO, Ludmila	ARG
7.	LAHITON, Agustina	ARG
7.	ELIZECHE, Ayelen	ARG



# Pan-American Open Bariloche 2020

(ARG Bariloche, 7-8 March 2020)

# -57 kg

9 Judoka

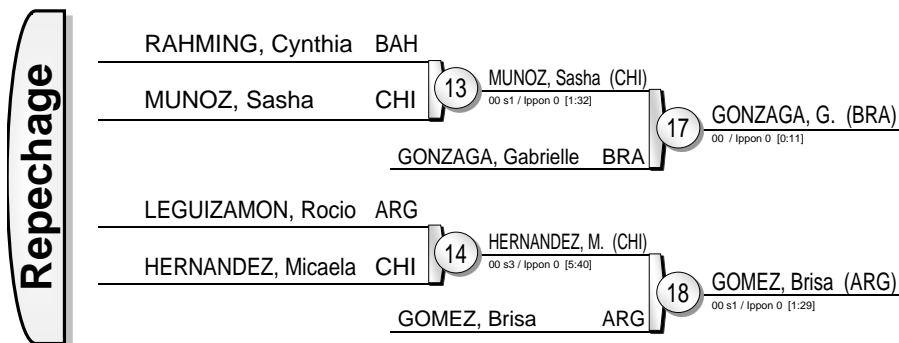

Results		
1.	VALENCIA, Karla	ECU
2.	GONZALEZ, Oritia	ARG
3.	GONZAGA, Gabrielle	BRA
3.	GOMEZ, Brisa	ARG
5.	MUNOZ, Sasha	CHI
5.	HERNANDEZ, Micaela	CHI
7.	RAHMING, Cynthia	BAH
7.	LEGUIZAMON, Rocio	ARG



# Pan-American Open Bariloche 2020

(ARG Bariloche, 7-8 March 2020)

# -63 kg

8 Judoka

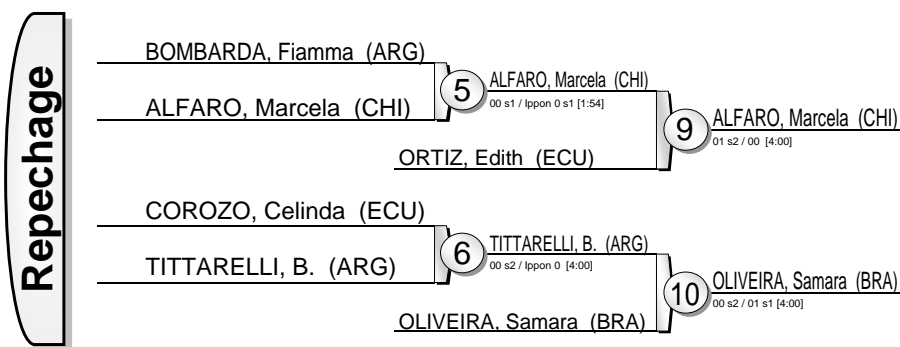
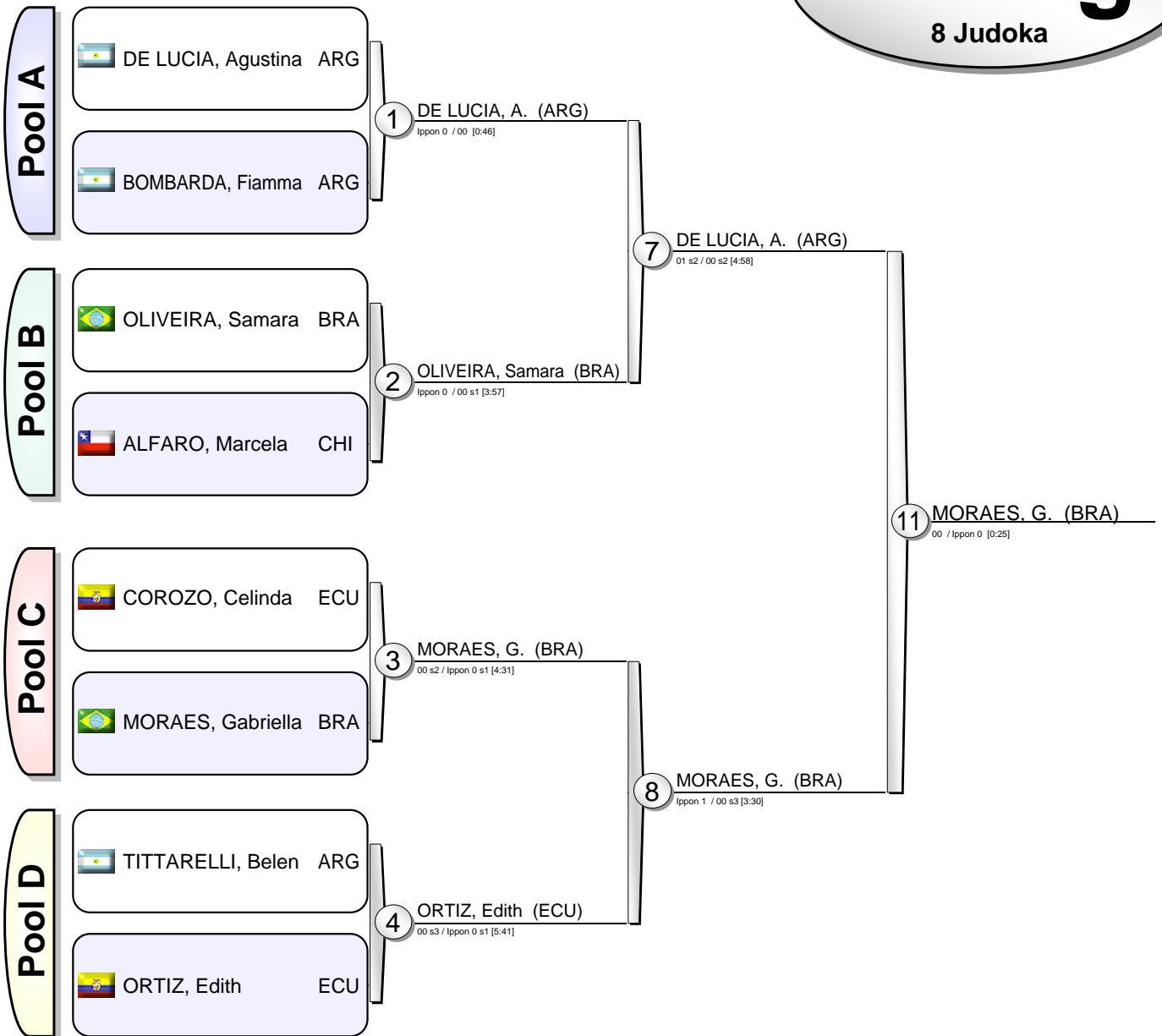

Results		
1.	MORAES, Gabriella	BRA
2.	DE LUCIA, Agustina	ARG
3.	ALFARO, Marcela	CHI
3.	OLIVEIRA, Samara	BRA
5.	ORTIZ, Edith	ECU
5.	TITTARELLI, Belen	ARG
7.	BOMBARDA, Fiamma	ARG
7.	COROZO, Celinda	ECU



# Pan-American Open Bariloche 2020

(ARG Bariloche, 7-8 March 2020)

## -70 kg

5 Judoka

	1	3	5	Wins	Scores
<b>1</b> FIGUEROA, Mackarena CHI		-	-	<b>0</b>	(0)
<b>3</b> OLIVEIRA, Thalia BRA	+		+	<b>2</b>	(20)
<b>5</b> DELVECCHIO, Victoria ARG	+	-		<b>1</b>	(10)

	2	4	Wins	Scores
<b>2</b> MORALES FALCONI, Xsara PER		+	<b>1</b>	(10)
<b>4</b> MYERS, Melissa USA	-		<b>0</b>	(0)

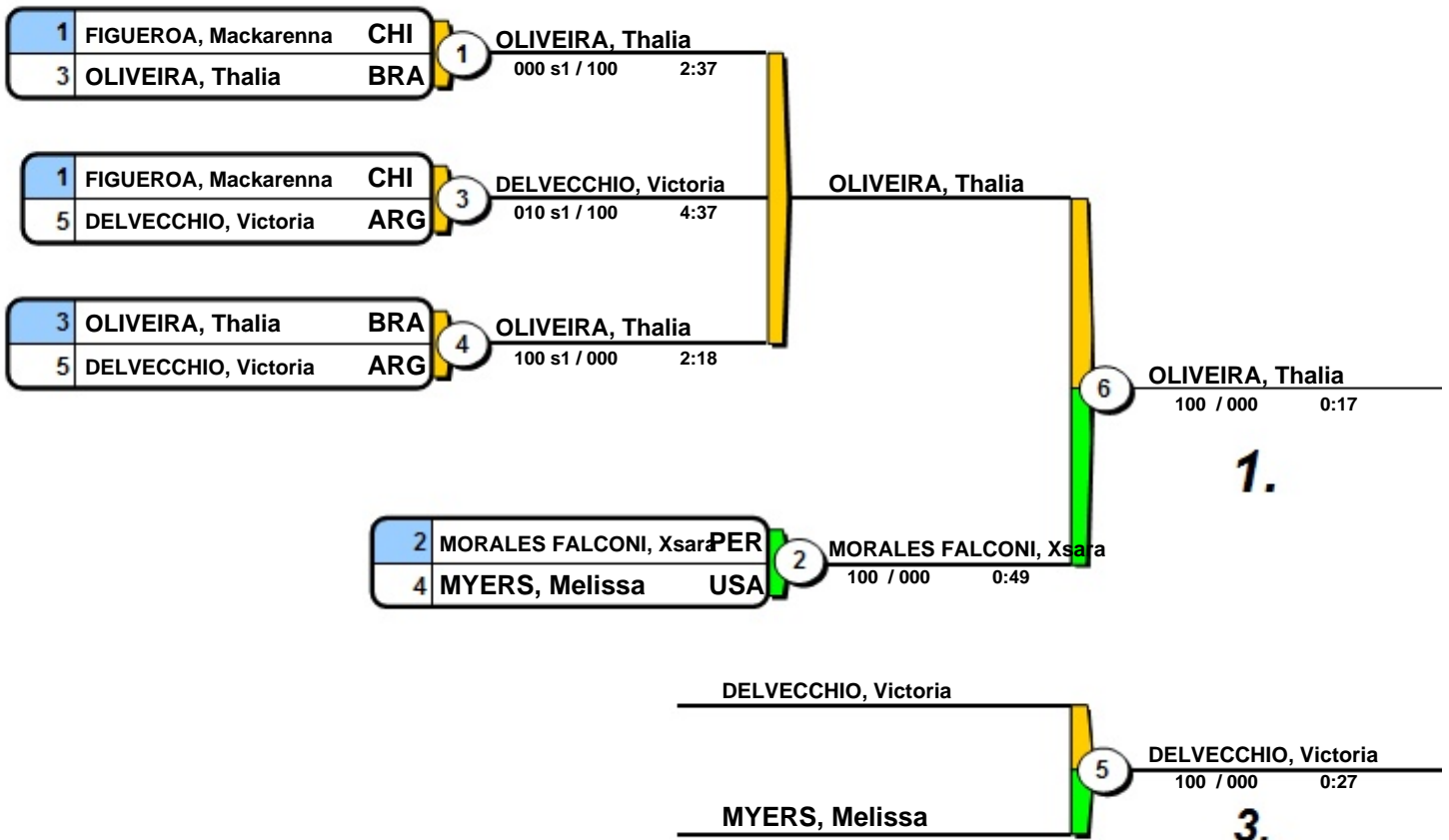

- 1. OLIVEIRA, Thalia BRA
- 2. MORALES FALCONI, Xsara PER
- 3. DELVECCHIO, Victoria ARG



# Pan-American Open Bariloche 2020

(ARG Bariloche, 7-8 March 2020)

# -78 kg

3 Judoka

			1	2	3		
1	BRANSER, Marie	COD		+	+	2 (17)	
				10	7		
2	CANTERO, Lucia	ARG	-		+	1 (10)	
					10		
3	STOUT, Nicole	USA	-	-		0 (0)	

1	BRANSER, Marie	COD	1	BRANSER, Marie	COD	100 s2 / 000 s2	3:39
2	CANTERO, Lucia	ARG					

1	BRANSER, Marie	COD	2	BRANSER, Marie	COD	010 s1 / 000 s2	4:00
3	STOUT, Nicole	USA					

2	CANTERO, Lucia	ARG	3	CANTERO, Lucia	ARG	100 / 000	2:23
3	STOUT, Nicole	USA					

- 1. BRANSER, Marie      COD
- 2. CANTERO, Lucia    ARG



# Pan-American Open Bariloche 2020

(ARG Bariloche, 7-8 March 2020)

## +78 kg

3 Judoka

			1	2	3		
1	WOOD, Gabriella	TTO		+	-	1 (10)	
2	BREDESTON, Amanda	ARG	-		-	0 (0)	
3	BOLIVAR GONZALES, Yuliana	PER	+	+		2 (20)	

1	WOOD, Gabriella	TTO	1	WOOD, Gabriella	TTO
2	BREDESTON, Amanda	ARG		110 s1 / 010 s2	8:10

1	WOOD, Gabriella	TTO	2	BOLIVAR GONZALES, Yuliana	PER
3	BOLIVAR GONZALES, Yuliana	PER		000 / 100 s1	1:36

2	BREDESTON, Amanda	ARG	3	BOLIVAR GONZALES, Yuliana	PER
3	BOLIVAR GONZALES, Yuliana	PER		000 s1 / 110	1:21

1. BOLIVAR GONZALES, Yuliana PER
2. WOOD, Gabriella TTO